

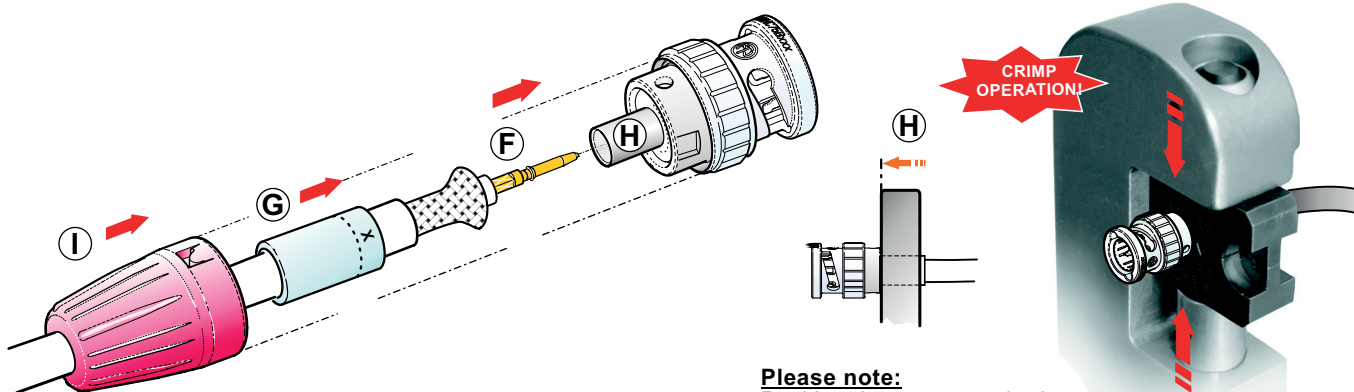

Assembly Instruction

Neutrik NBNC75BFG7 BNC Plug Image 360

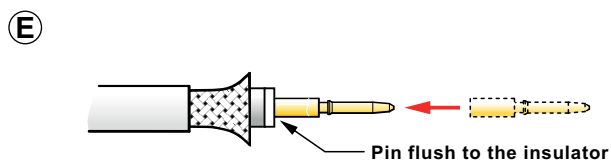
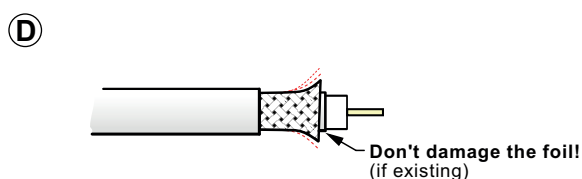
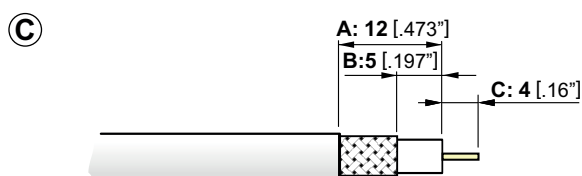
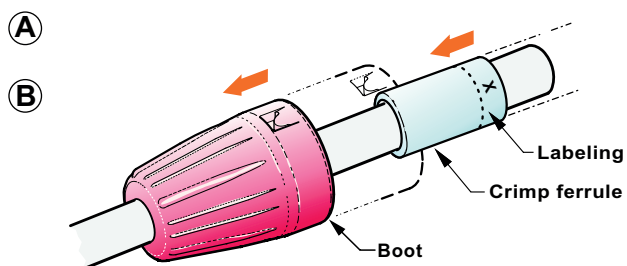

Assembled Connector

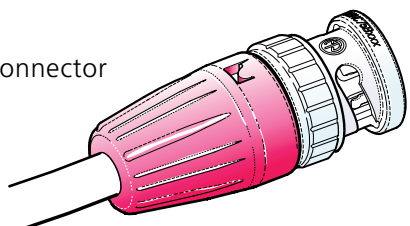

A Slide the boot onto the cable
- Position the labeling to the cabelend

B Slide the crimp ferrule onto the cable

C Prepare cable as shown
- Use an adjustable coaxial cable stripper

D Spread the braided shield

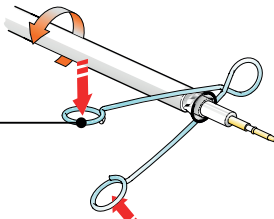
(It's easily with the NEUTRIK®
"SHIELD-SPREADING-TOOL"!) 

E Crimp the pin

- position the pin on the center conductor
- Crimp the pin with the tool

(For best crimping-results it is recommended to use the original Neutrik crimp tool
- HXBNC with the corresponding insert
or hexcrimp acc. to IEC 803-W (SW 1.7)
or squarecrimp acc. to IEC 803-2 (SW 1.6)

- Pin can also be soldered (Optional)!
- Straighten the pin if misaligned.

F Insert the cable into the connector body

G Slide the crimp ferrule over the shield to the front and push the cable to its end position until you hear a snap noise.

Please note:
Position the connector body
Flush with the die face.

H Crimp the ferrule with the tool

(For best crimping-results it is recommended to use the original Neutrik tool - HXBNC with the corresponding insert)

I Snap the boot onto the connector body